

sealskin

KB19
KB20
KB01

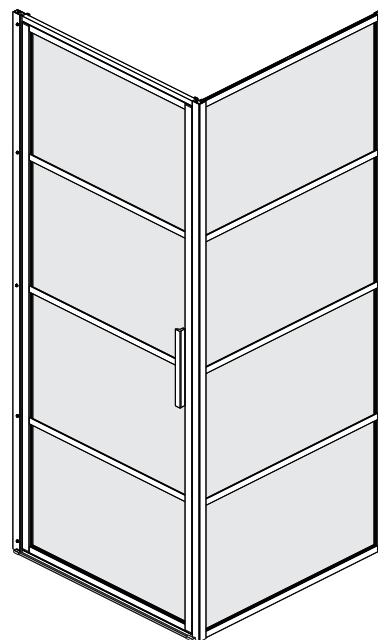

SOHO

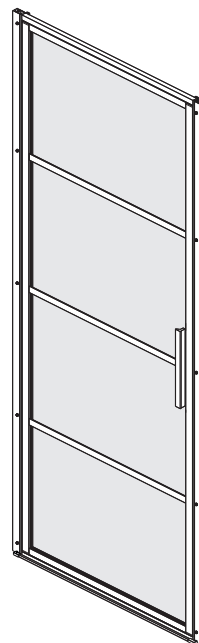
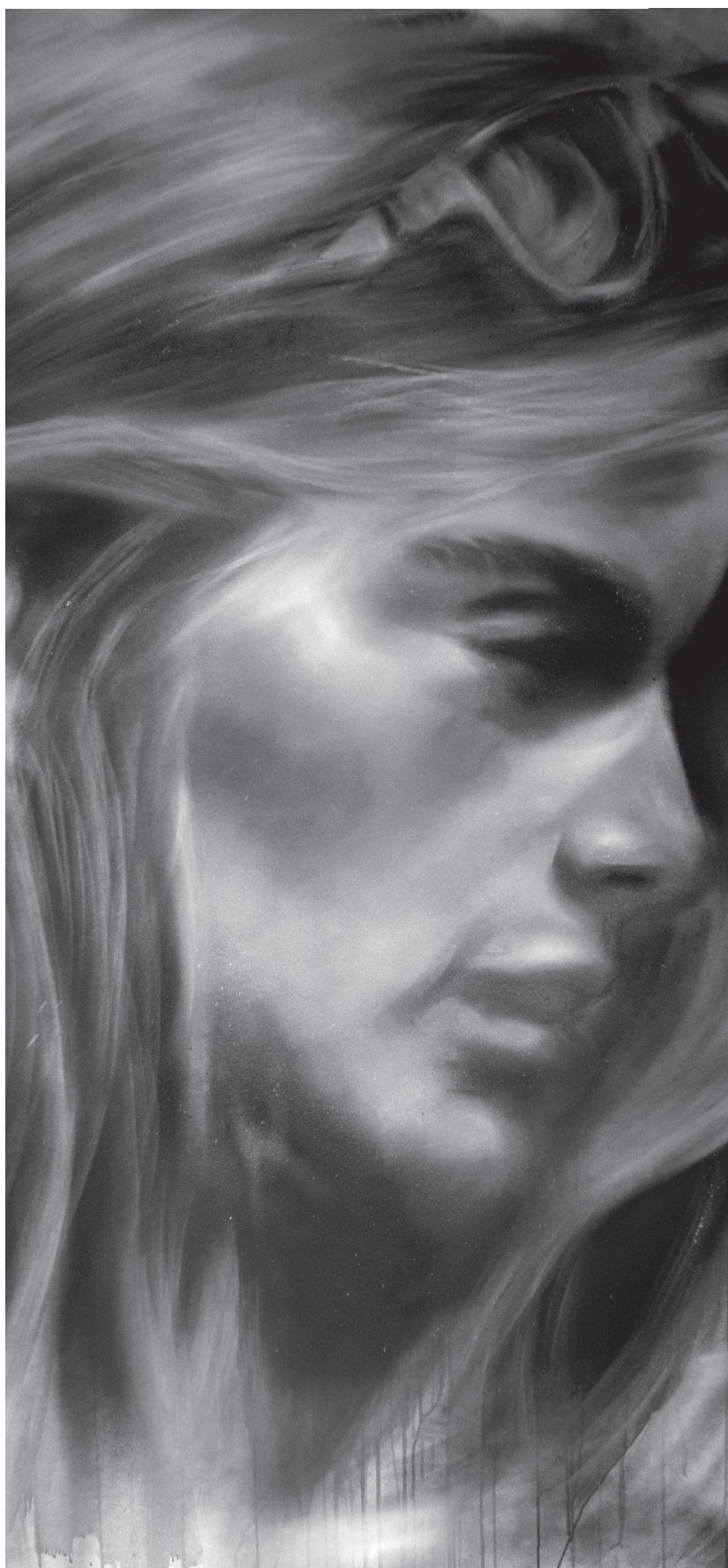

Included

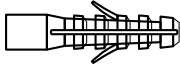

MUUR PLUG
CHEVILLE
WALL ANCHORS



SCHROEVEN
VIS
SCREWS

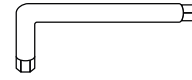

INBUSLEUTEL
CLÉALLEN
ALLEN KEY

Additional tools

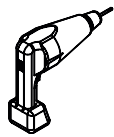

BOOR
PERCEUSE
DRILL

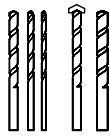

BOOR BITS: 3.0MM, 6.0MM
FORETS: 3.0MM, 6.0MM
DRILL BITS: 3.0MM, 6.0MM
DRILL BITS: 4.0MM, 6.0MM

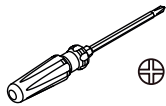

SCHROEVENDRAAIER
TOURNEVIS
SCREW DRIVER



SILICONENKIT
SILICONE
SILICONE

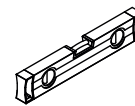

WATERPAS
NIVEAU
BUBBLE LEVEL

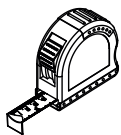

MEETLINT
RUBAN À MESURER
MEASURING TAPE



POTLOOD
CRAYON
PENCIL

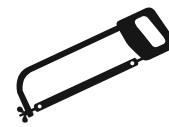

IJZER ZAAG
SCIE À FER
METAL SAW

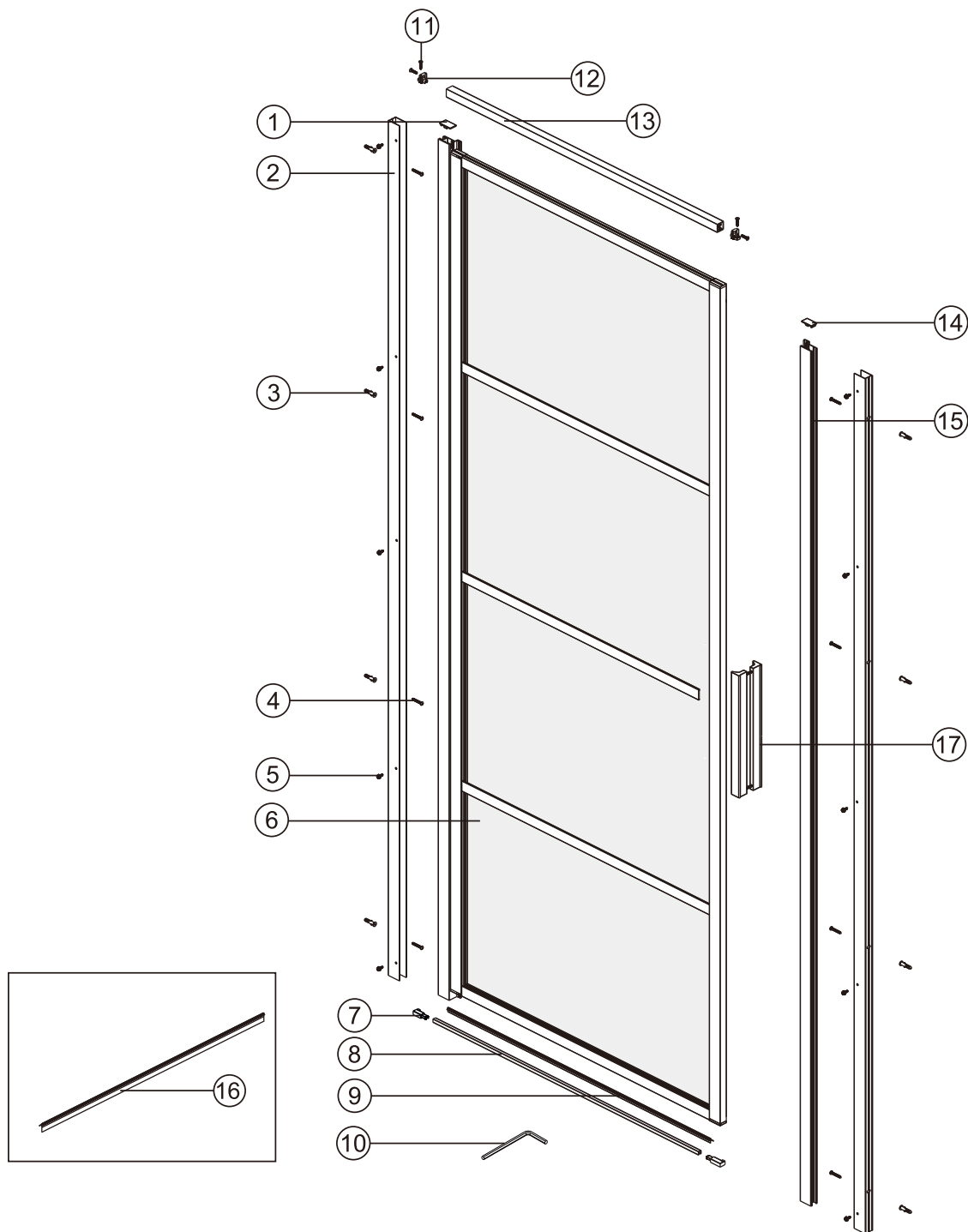

| NO | Qty | Description | NO | Qty | Description |
|----|-----|-------------------------------------|----|-----|---------------------------------------|
| 1 | 1 | Wall profile top cover | 10 | 1 | Allen key |
| 2 | 2 | Wall profile | 11 | 4 | Cross head countersunk screw ST3.5X20 |
| 3 | 8 | Wall anchor | 12 | 2 | Bracket for Horizontal bar |
| 4 | 8 | Cross head screw ST4X30 | 13 | 1 | Horizontal bar |
| 5 | 10 | Phillip head hexagon screw ST4.8X12 | 14 | 1 | Wall profile top cover |
| 6 | 1 | Door panel | 15 | 1 | Magnet profile |
| 7 | 2 | Threshold part L/R | 16 | 1 | Bottom gasket B |
| 8 | 1 | Back splash | 17 | 1 | Handle |
| 9 | 1 | Bottom gasket A | | | |

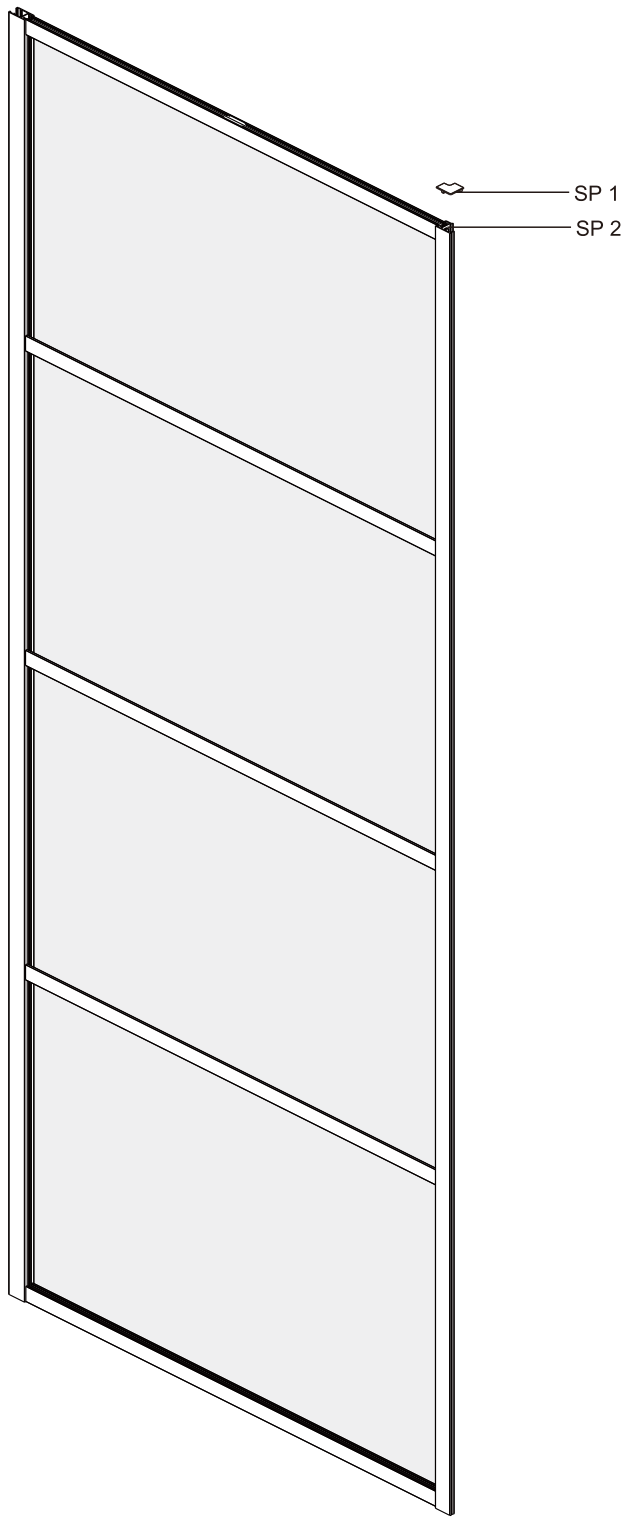

| NO | Qty | Description |
|------|-----|--------------------------|
| SP 1 | 1 | Corner profile top cover |
| SP 2 | 1 | Return panel |

A 01

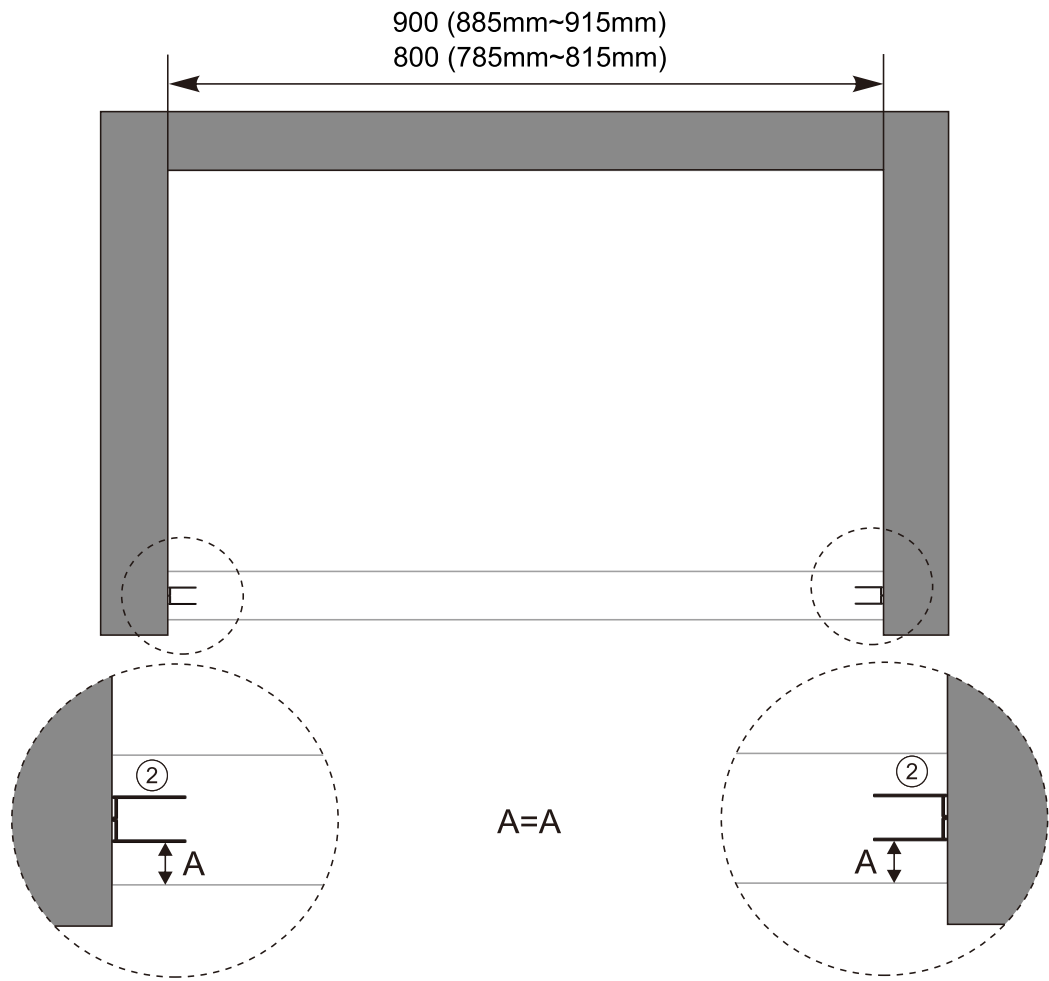

A 02

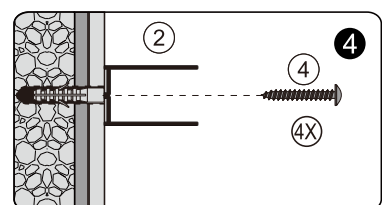
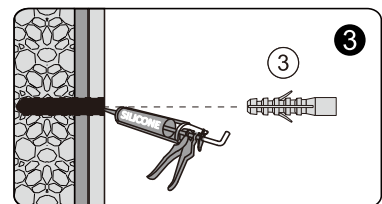
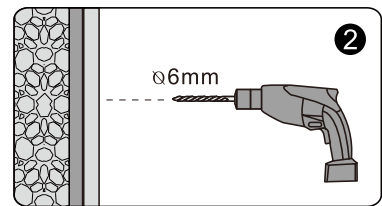
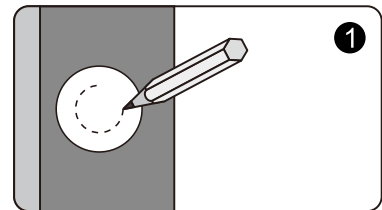
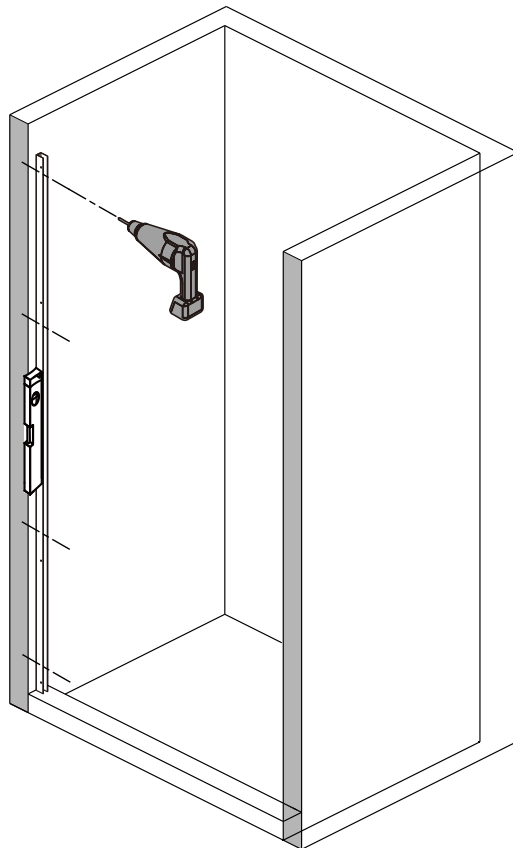

A 03

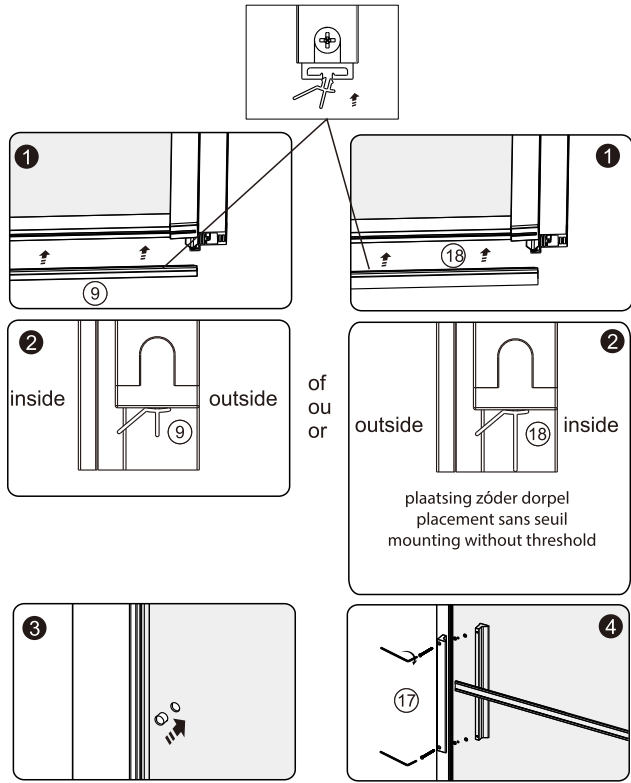
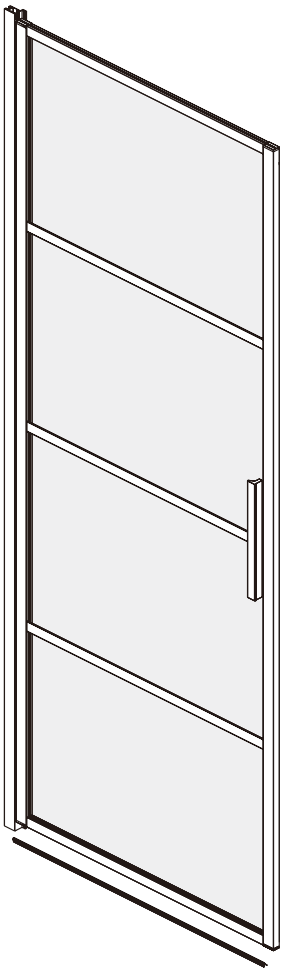

A 04

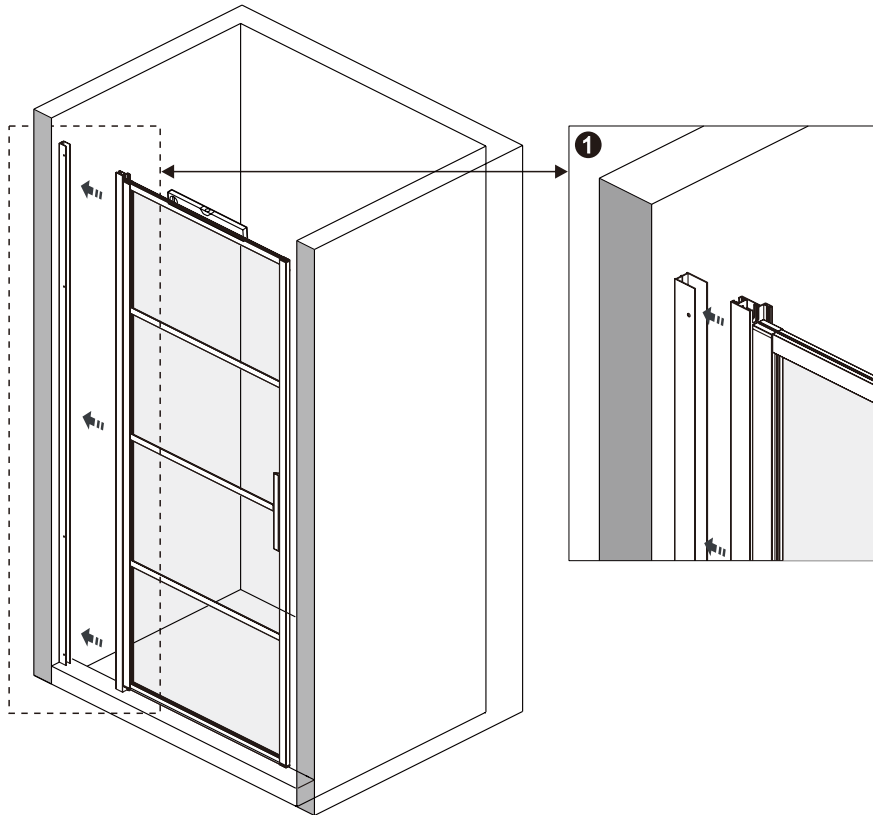

A 05

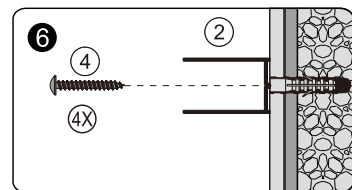
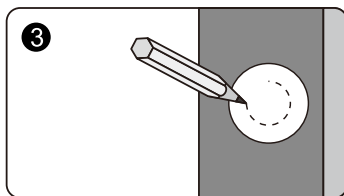
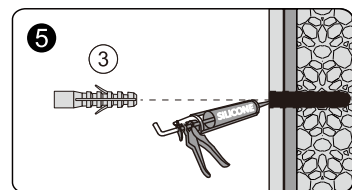
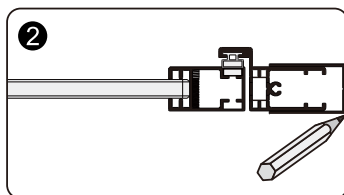
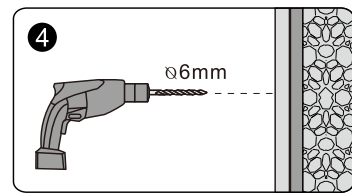
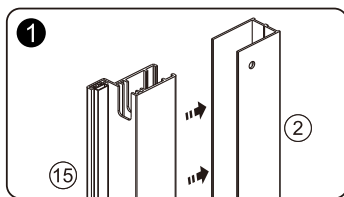
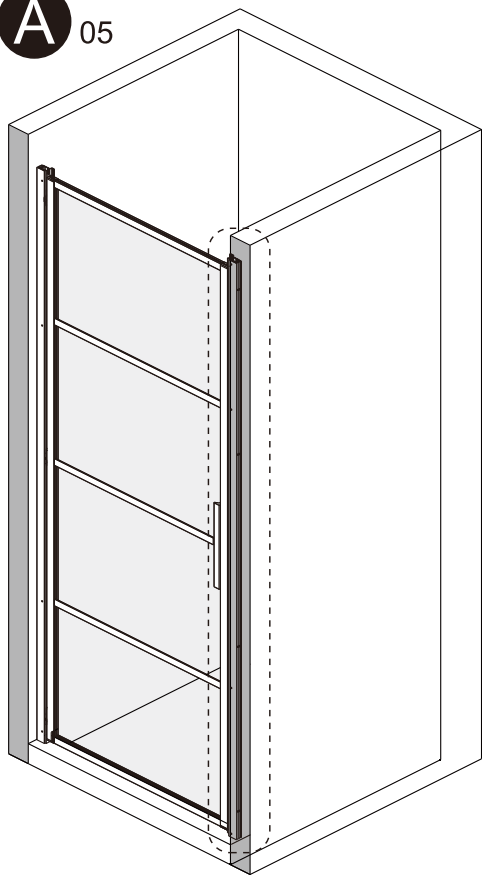

A 06

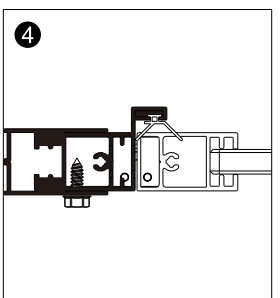
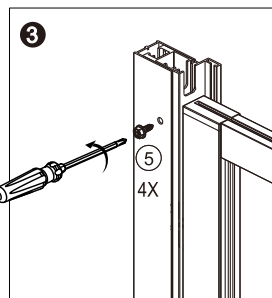
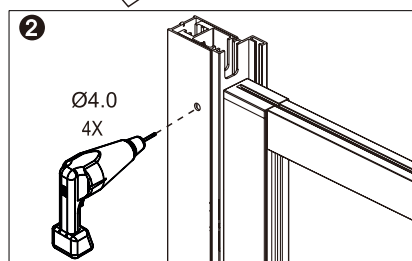
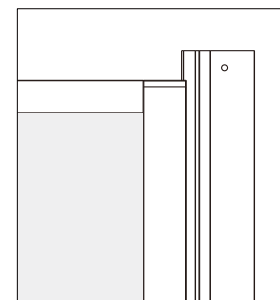
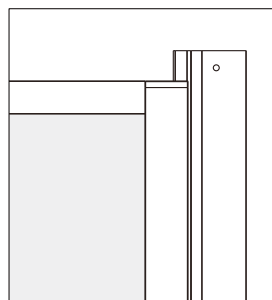
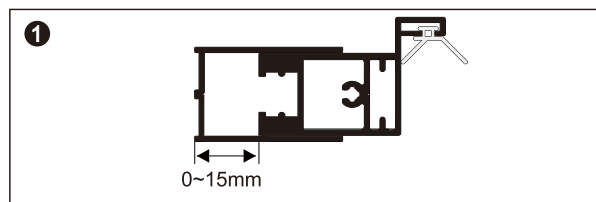
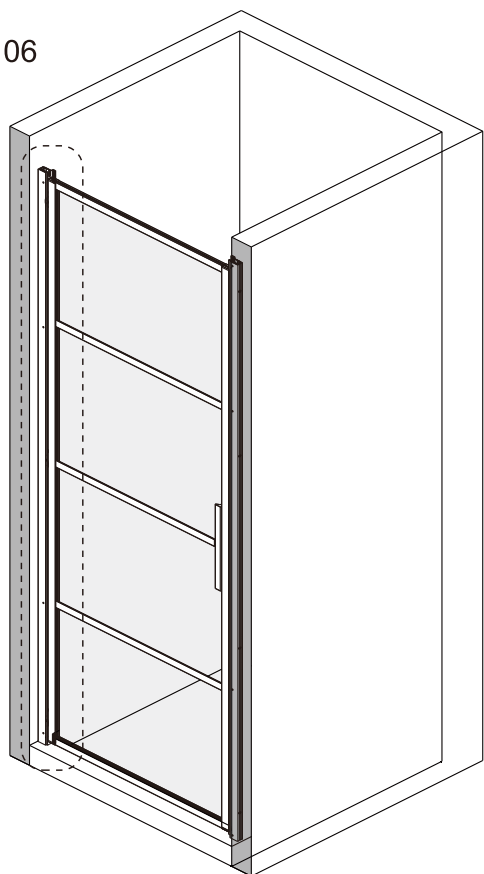

A 07

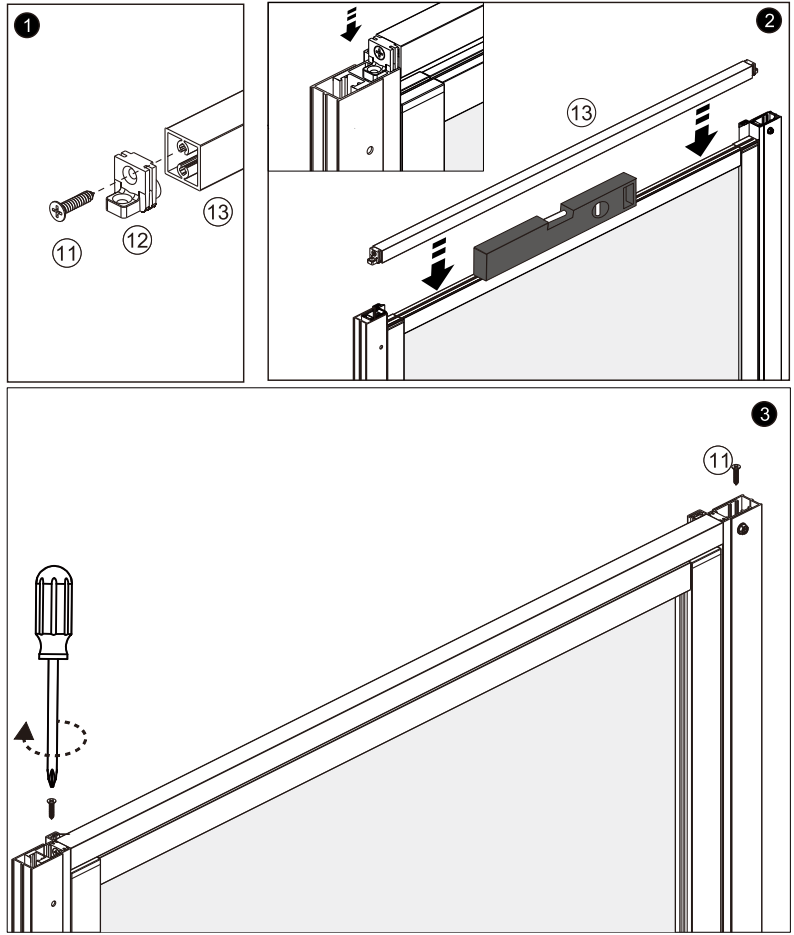
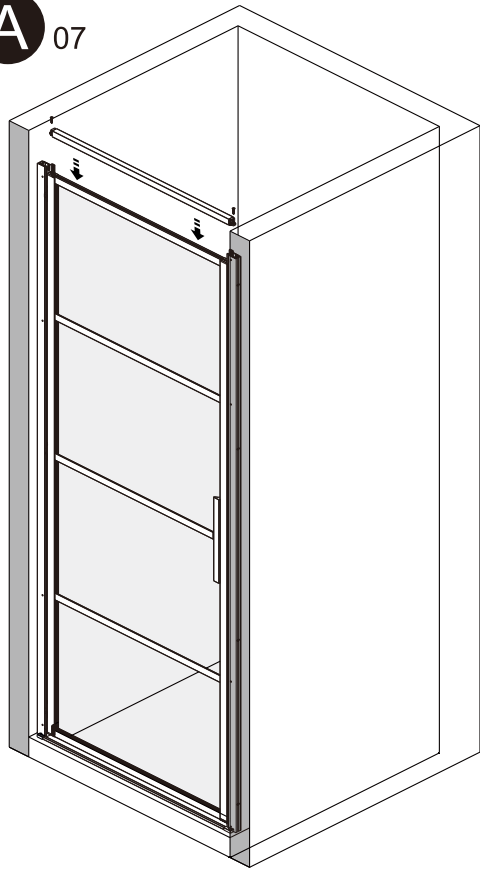

A 08

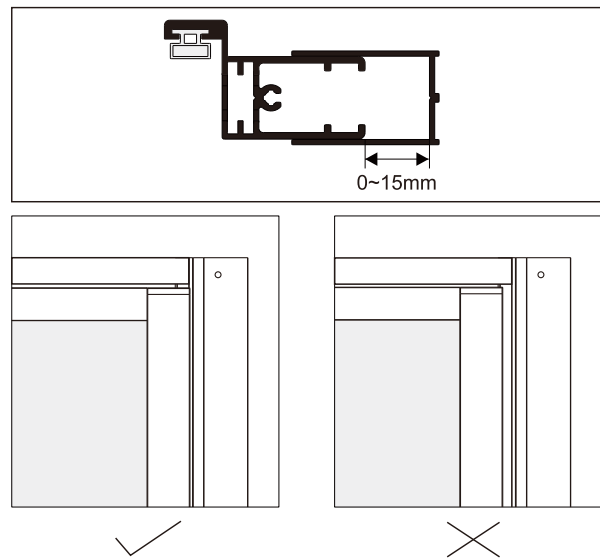
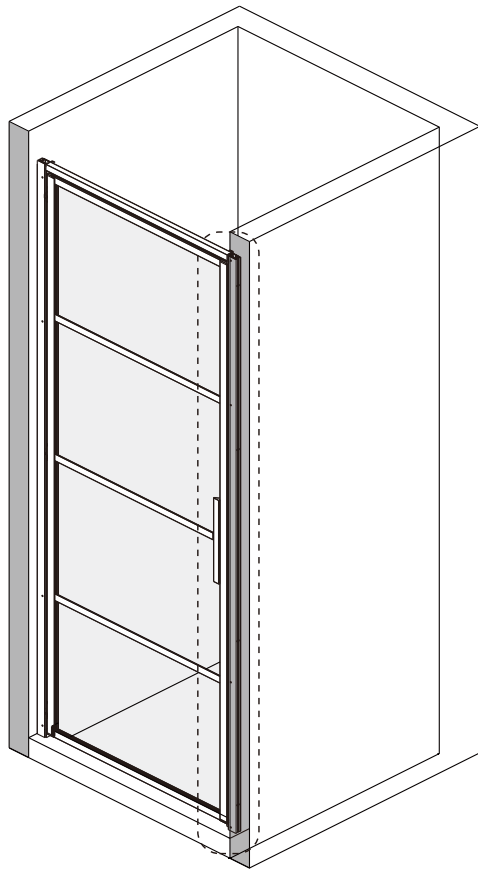

A 09

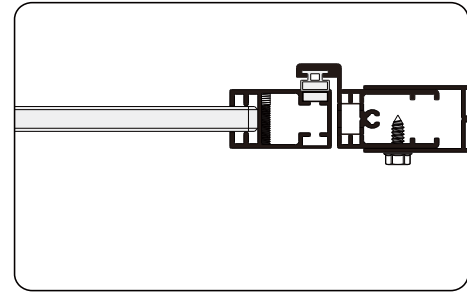
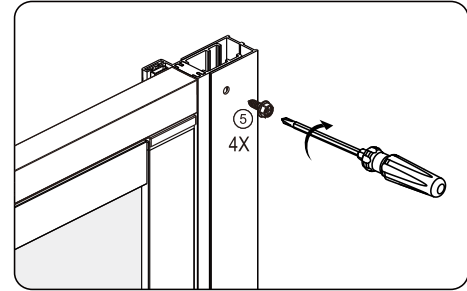
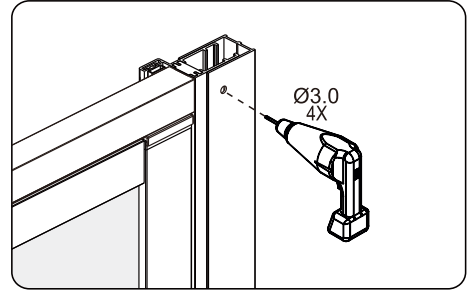
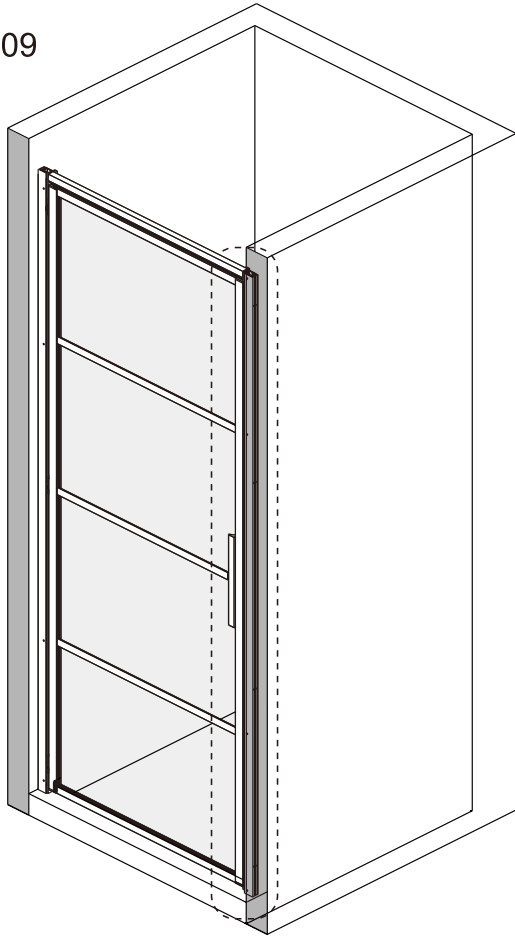

A 10

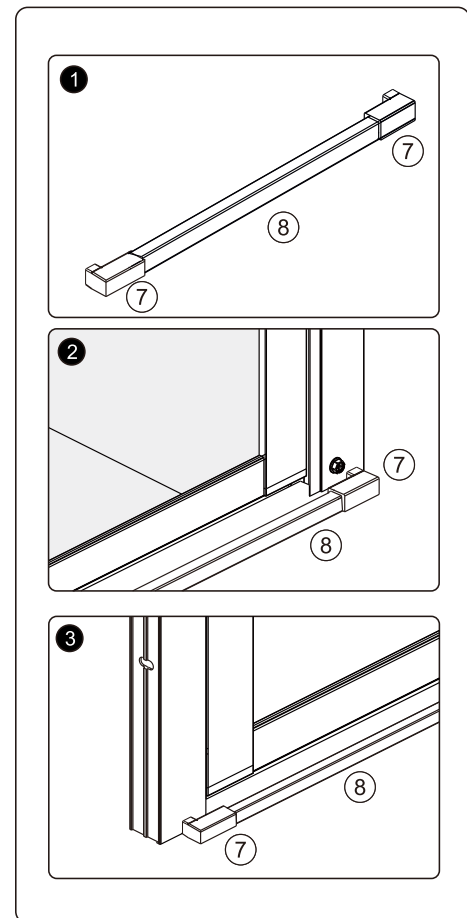
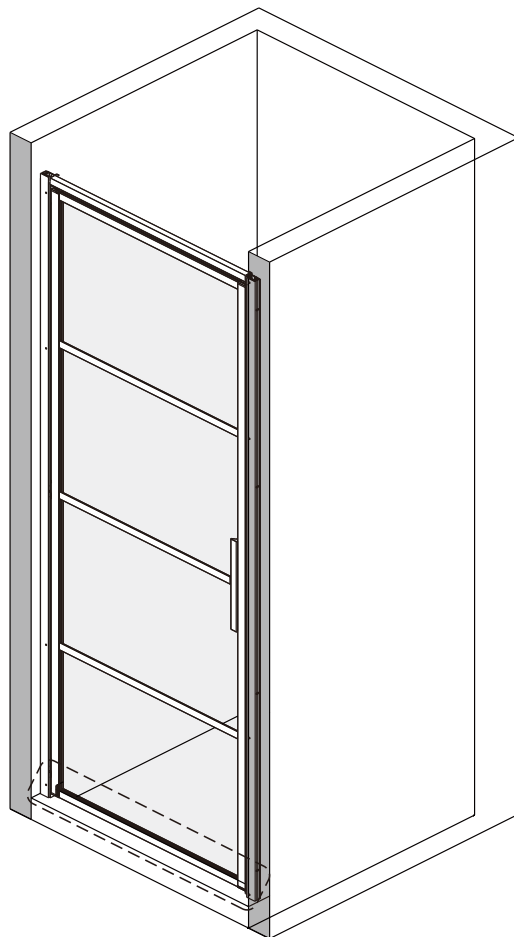

A 11

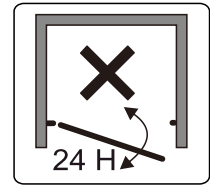
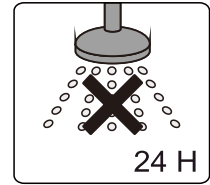
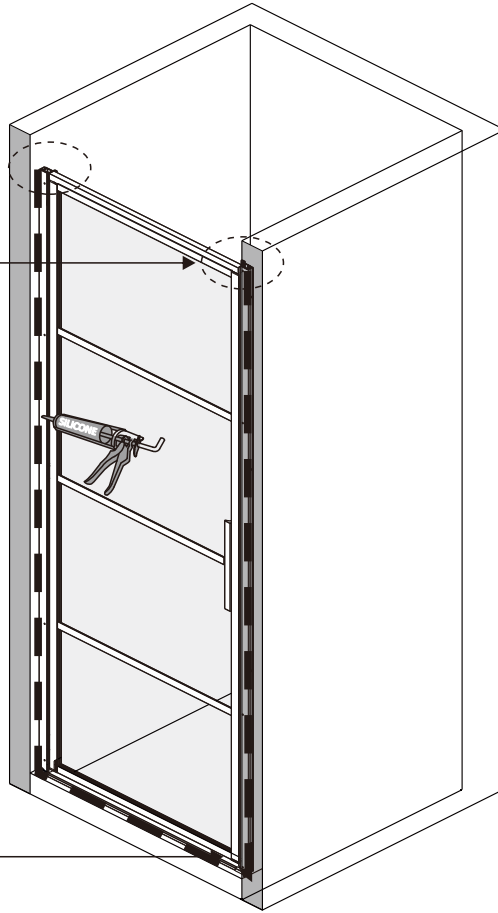
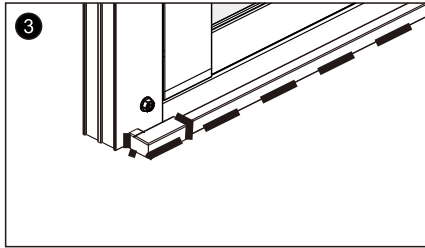
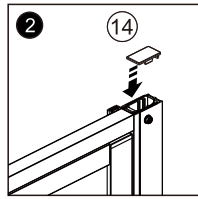
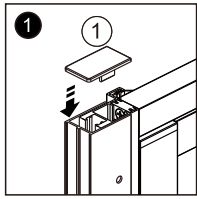

B 01

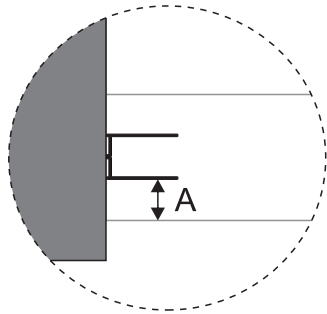
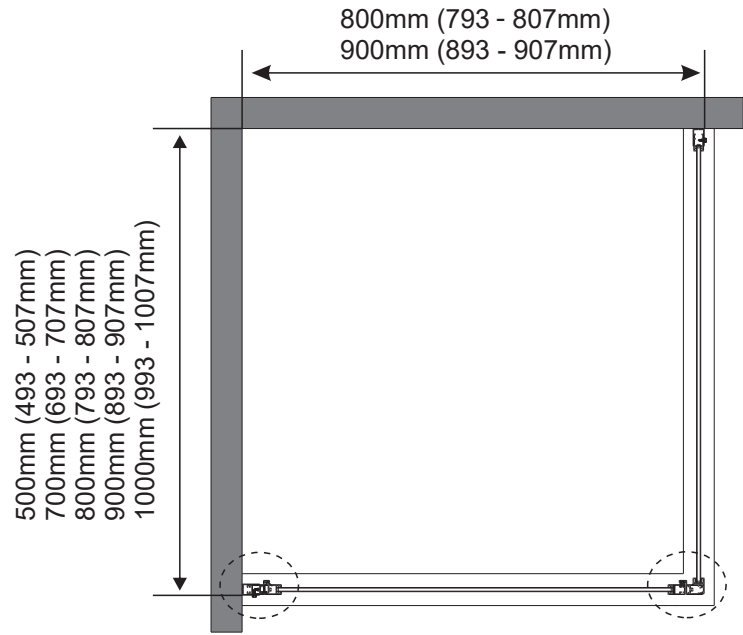

$A=B+1$

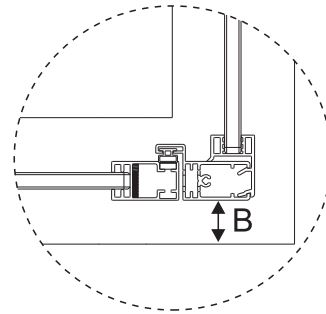

B 02

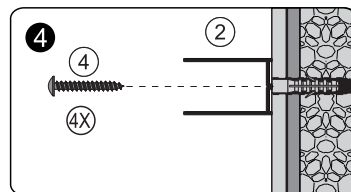
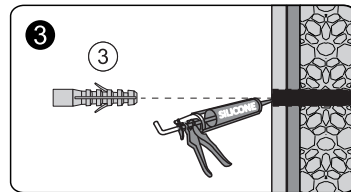
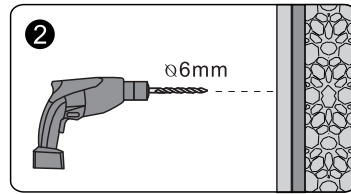
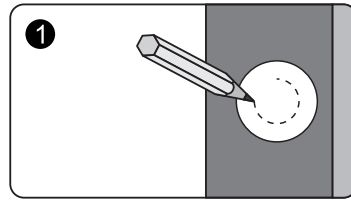
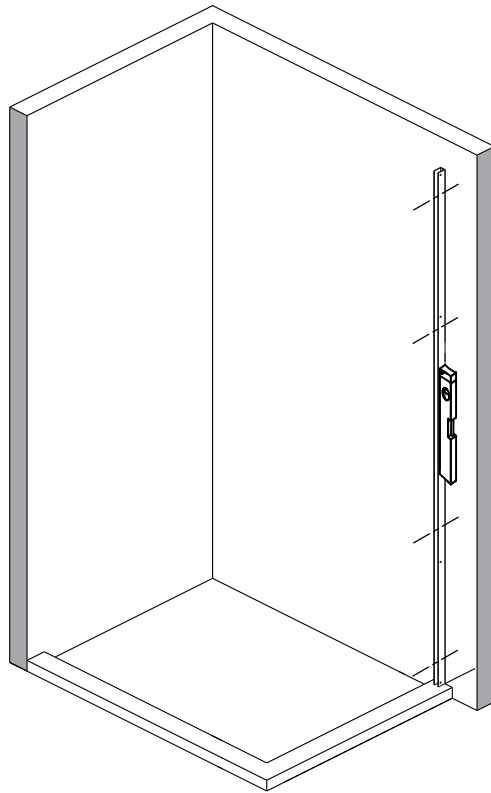

B 03

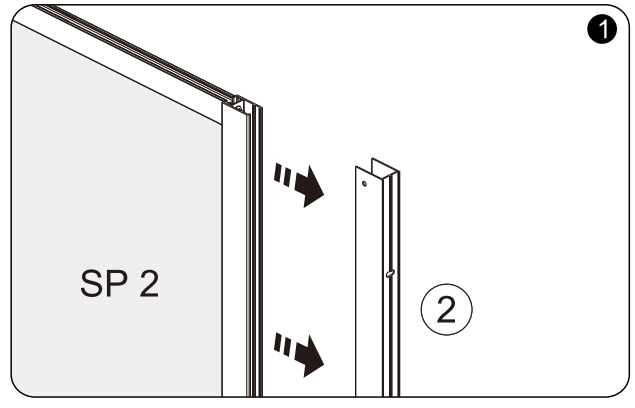
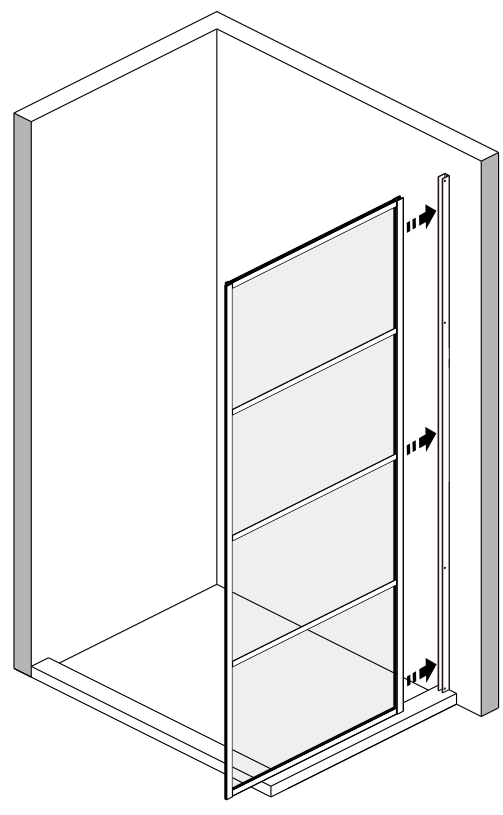

B 04

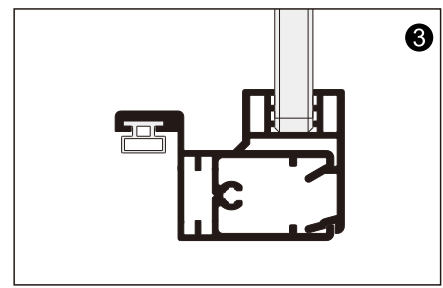
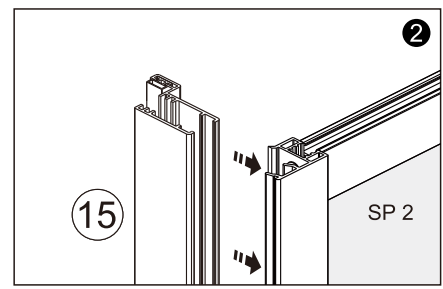
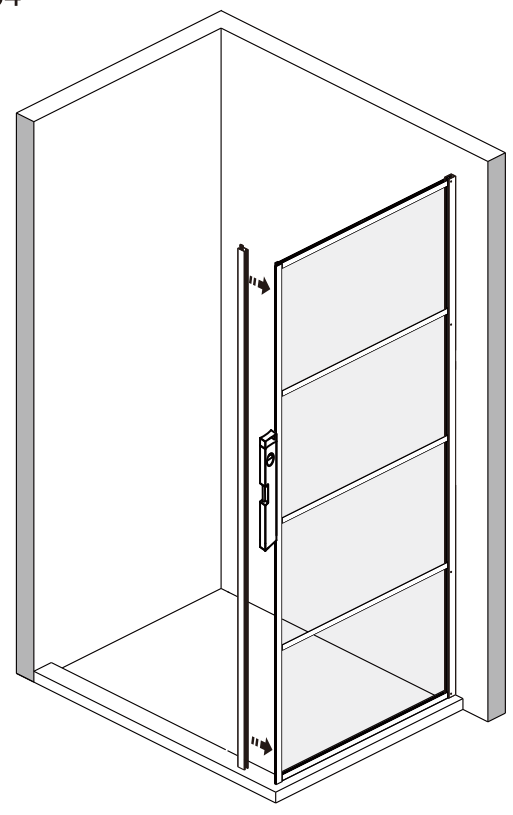

B 05

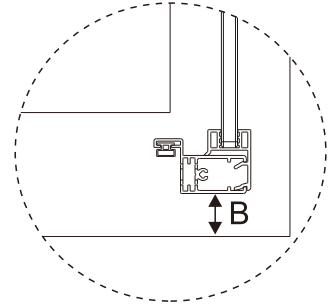
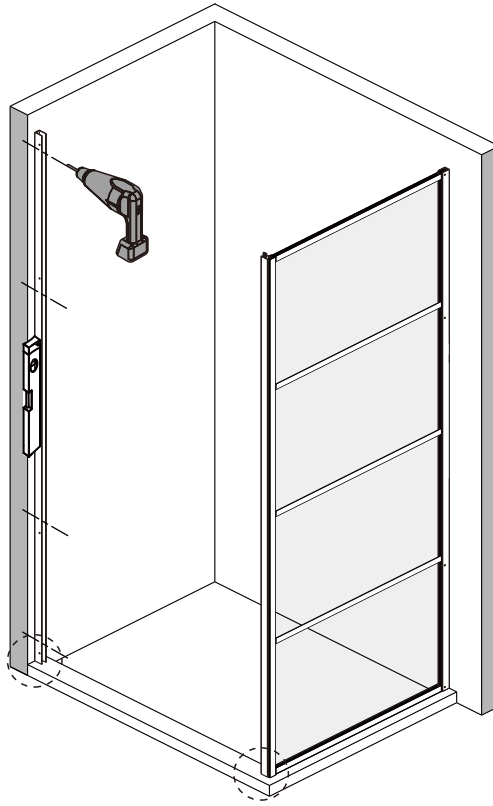
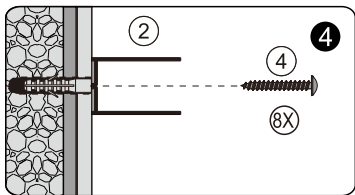
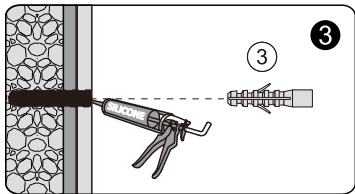
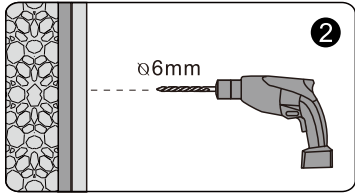
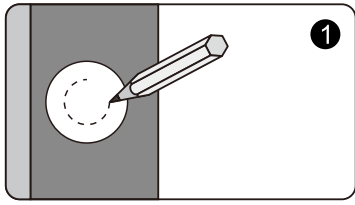

$A = B + 1$

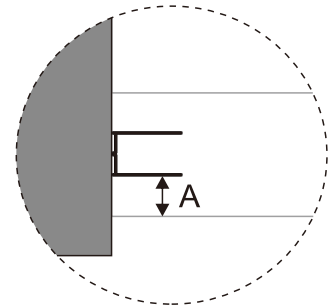

B 06

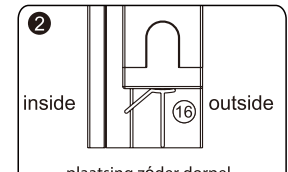
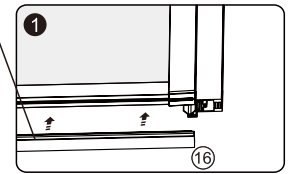
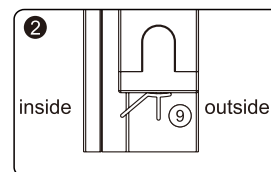
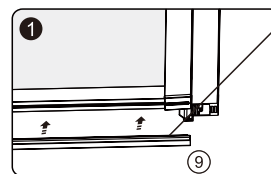
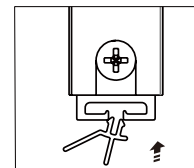
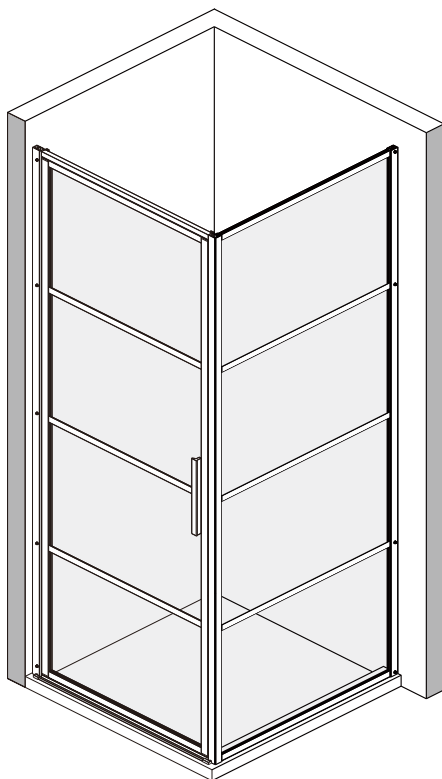

of
ou
or

plaatsing zóder dorpel
placement sans seuil
mounting without threshold

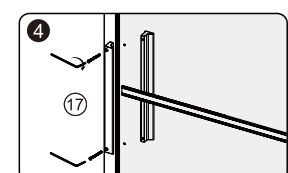
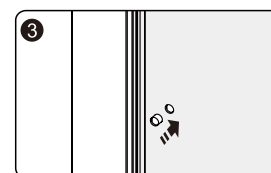

B 07

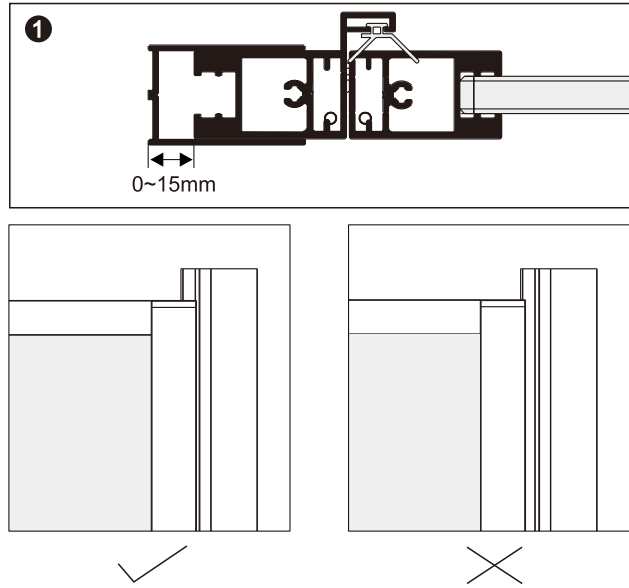
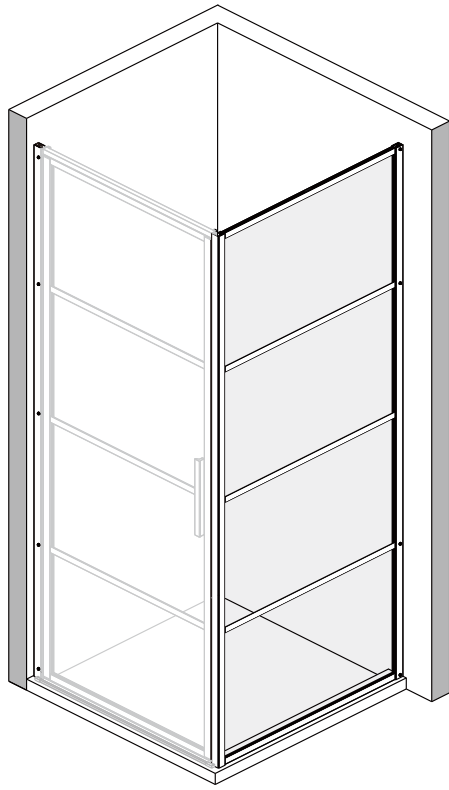

B 08

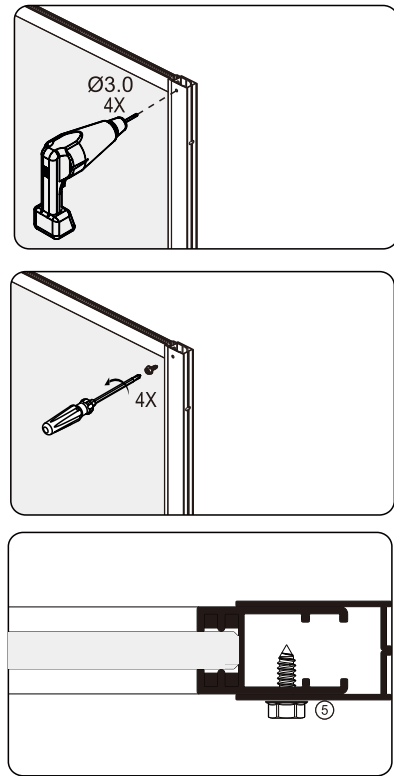
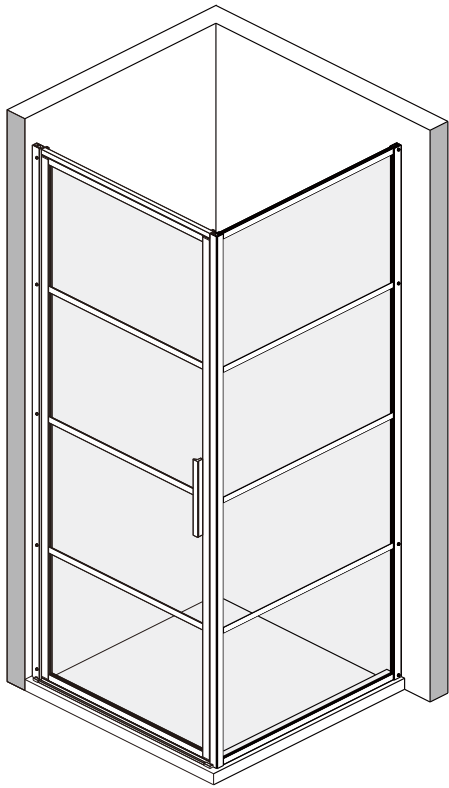

B 09

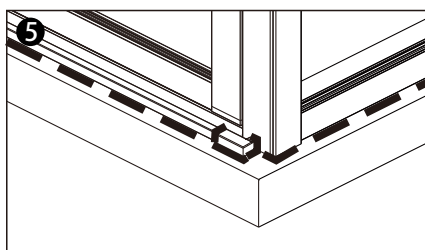
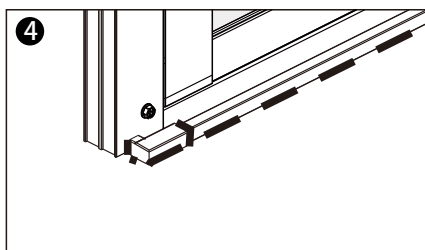
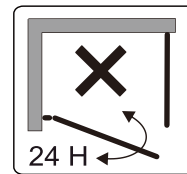
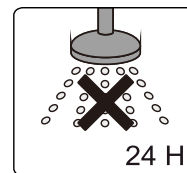
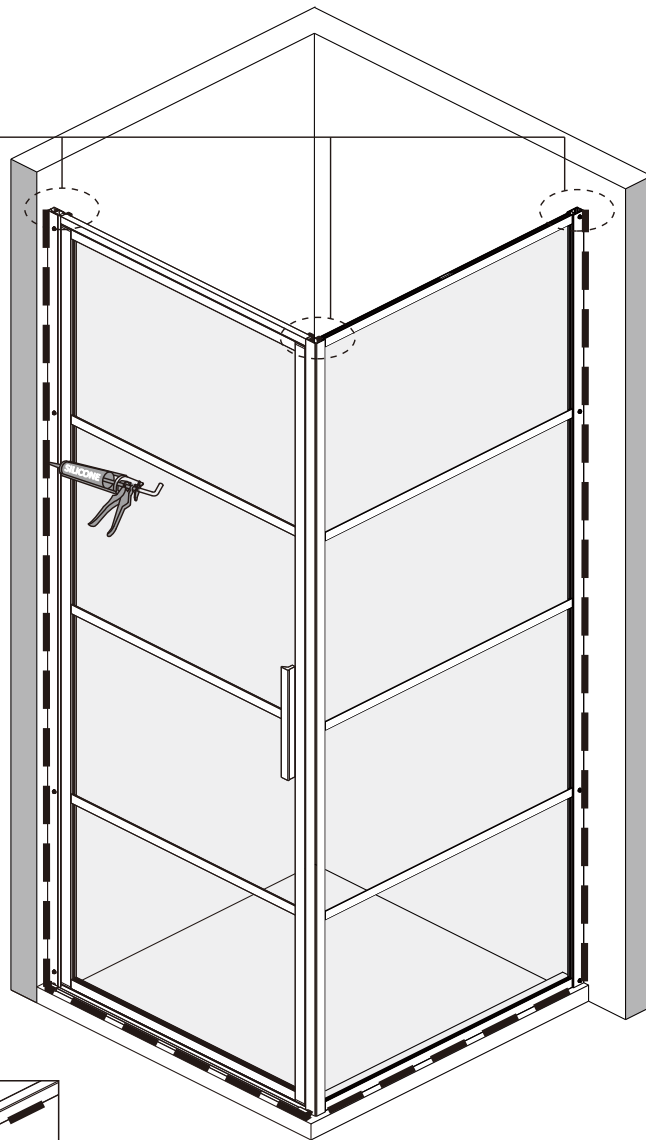
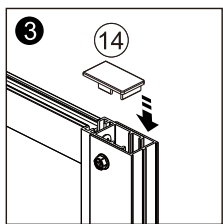
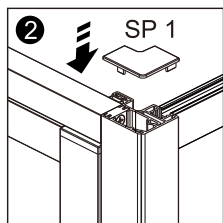
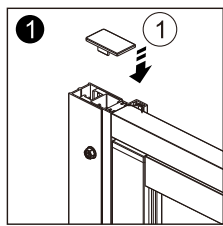

NL Voor de reiniging dient u een PH neutraal reinigingsmiddel of de aanbevolen Sealskin douchereiniger te gebruiken. Geen verdunner, alkalische, zuur, chloor of schurende middelen gebruiken.

GB For cleaning use a pH-neutral cleaning agent or the special cleaner recommended by us. Not to use are solvents, as well as alkaline, solvent -, acid- and chloric or scrubbing agents.

FR Pour nettoyer veuillez utiliser s'il vous plaît un produit de nettoyage avec PH neutre ou le produit spéciale recommandé par nous. N'utilisez pas des solvants, ainsi qu'alcalins, acides ou produits avec du chlore ou agressif.

DE Zur Reinigung benutzen Sie ein PH-neutrales Reinigungsmittel oder den von uns empfohlenen Spezialreiniger. Verwenden Sie keine scheuernden, alkalischen, säure- oder chlorhaltigen Reinigungsmittel sowie Oxidations- und Lösungsmittel.

PL Do mycia i pielęgnacji proszę używać środków czyszczących o odczynie PH obojętnym lub polecany przez nas specjalny preparat. Nie należy stosować rozpuszczalników, jak również preparatów alkalicznych, kwaśnych, zawierających chlor lub posiadających w aściwości ściernie.

SOHO

KB19
KB20
KB01

Garantiebewijs
Warranty card
Garantieschein
Carte de garantie
Certificato di garanzia
Certificado de garantía

This Sealskin product has a warranty period of 5 years. Normal wear and tear on components such as gaskets are excluded from this warranty.

Wholesale dealer:

Address:

Phone:

Fax:

Installer:

Address:

Phone:

Fax:



NL De producent houdt zich het recht voor, ten alle tijde zonder tegenbericht, veranderingen door te voeren.
GB The producer reserves the right to modify the product at any time without prior notice.
DE Der Produzent behält sich jederzeit das Recht, ohne Vorbescheid Abänderungen vorzunehmen.
FR Le producteur se réserve le droit de modifier le produit sans aucun préavis.
SV Tillverkaren förbehåller sig all rätt att produktförändra
PL Producent rezerwuje sobie prawo modyfikacji produktu bez wczesniejszego powiadomienia.

sealskin 